

NS-ACL10W-02C

LED Energy Saving light



General illumination
 Outdoor use in outdoor luminaires only (minimum Ip65)
 Reduces lumen maintain flux and working life if used
 in sealed lamp fixtures. ①

Product features

- 360 - degree lighting angle, natural ventilation and heat dissipation
No fan design.
- Adopt the folding process of high heat conductivity and light stamping aluminum material to increase the heat dissipation area and accelerate the heat dissipation.
- Green products are light and convenient without ultraviolet and infrared radiation.
- Not suitable for dimmers ,electronic switches and remote controls .
- Dust and fire-proof, IP64.
- Widely replace HID/HPS/MH/CFL.
- Indoor and outdoor illumination: used to Garden lights, underground parking, supermarkets, hang a wall lamp, lamp warehouse, Office lighting, etc

Applications

Wall Lamp

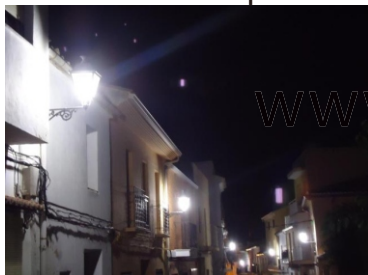

warehouse



office





Technical data

Electrical data

Rated wattage	10-12 W
Input Voltage	100-277VAC
Operating frequency	50/60 Hz
Rated power factor λ	>0.90
Power Efficiency	>0.87
Humidity	< 90%
Ambient temperature	-40~45°C
Base (standard designation)	E26/E27
Replacement conventional lamp power	HPS/HID/MH/CFL Lamp 35W
Dimmable	NO

Light technical data

Light Source/Count	70pcs 2835 0.2W LED
Luminous flux	.1300±200Lm
Color temperature	Warm White: 3000 ~3,500 K NaturalWhite: 4,000~5,000 K CoolWhite:5,500 ~6,500K
Color rendering index Ra	Ra > 80
Starting time	0 S
LED Emitter Life	50000hrs
Lifepan of LED Lamp	35000hrs

Dimensions & weight

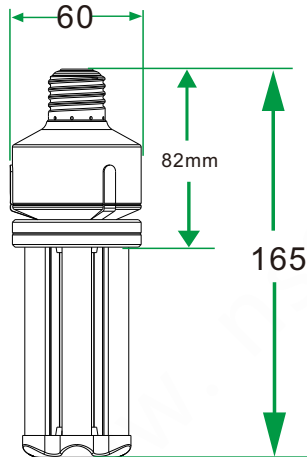

Base	E26/E27
Overall length	165m
Diameter	60mm
N. W	148g

Logistical Data

Package

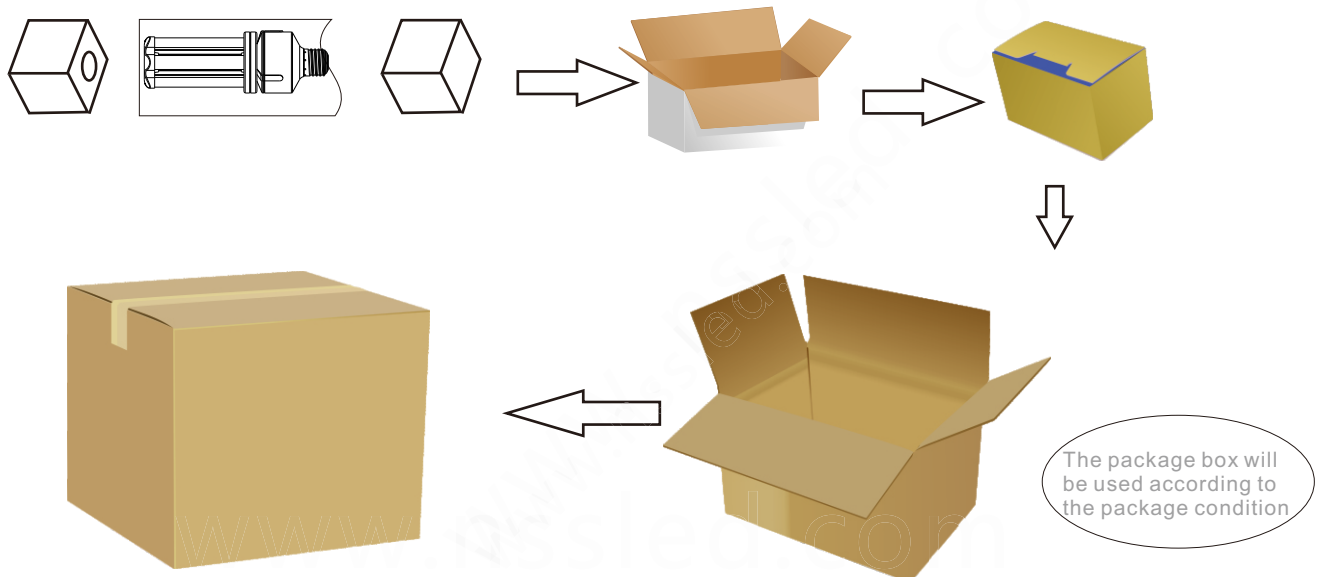

Packaging unit (Pieces/Unit)	Dimensions	Gross weight	Volume
Small box 1	20.2*9.2*9.2cm	220g	0.002m ³
Outer Carton 40	48*42*39.5cm	10Kg	0.080m ³

Installation

Replace CFL

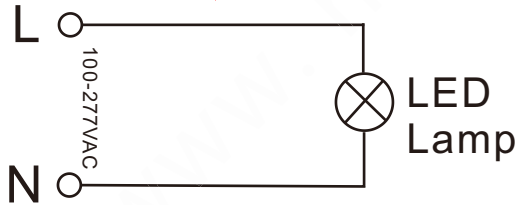
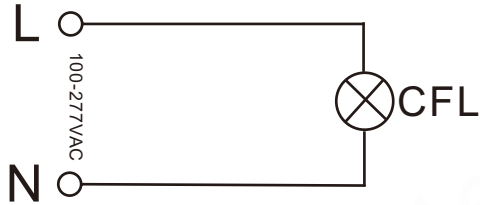

Replace HPS/HID/MH

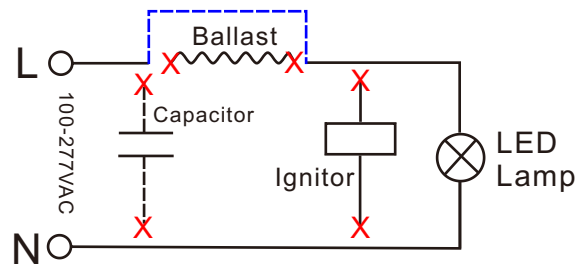
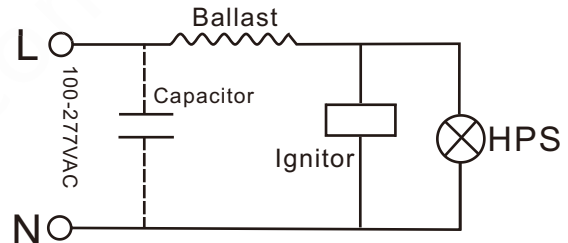

Light Distribution diagram

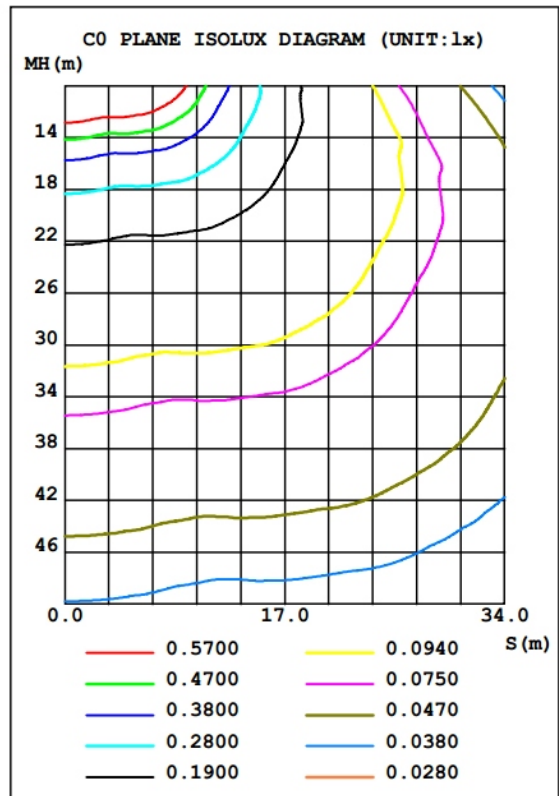
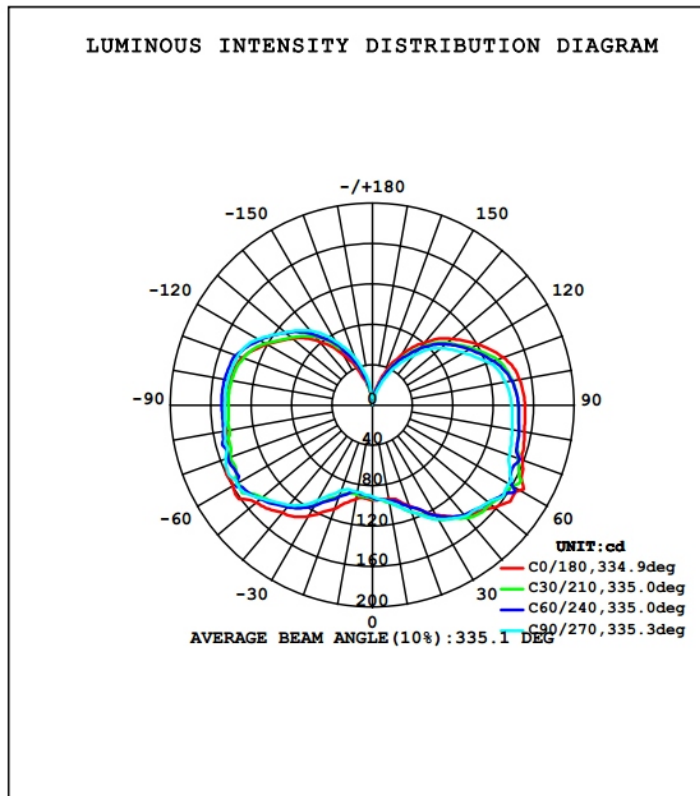

Product datasheet

Attention ①

When the products are used in the outdoor lighting, ensure the space is waterproof and well ventilated. Pay attention to the size of the confined space. Ensure the lamp has enough space for heat dissipation which ensures lumen maintenance and extends its working life.

As shown below, for your reference

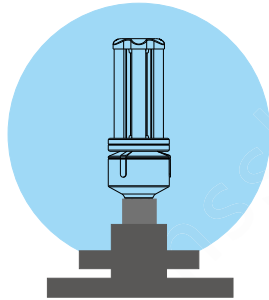

When 10W warehouse light is used in confined space, the diameter must be more than 20cm.

Attention ②

Key Benefits of comparison	LED Energy Saving light 10W	HPS/HID/MH/CFL Lamp 35W
Luminous Flux (Lm)	1300	1400
Efficiency(Lm/W)	125	40
Better Color Appearance Measured in color Rendering index	80	98
Wide Color Availability In CCT(kelvin)	2500-6500	2500
Starting Time, Quick Start (min)	0	0
The life of the lamp (H)	35000	5000



LED Energy Saving light 10W

Replacement



HPS/HID/MH/CFL Lamp 35W

Additional product data

All technical parameters apply to the entire lamp/Due to the complex production process for light-emitting diodes, the typical values shown for the technical LED parameters are purely statistical values that do not necessarily match the actual technical parameters of each individual product, which can vary from the typical value.

Disclaimer

Subject to change without notice. Errors and omission excepted. Always make sure to use the most recent release.