

NS-GLA100W-01C-U

LED Garden light



General illumination

Reduces lumen maintain flux and working life if used in sealed lamp fixtures. ①

Features

- Specially designed for indoor and outdoor lighting. This lamp could replace the traditional lamp directly. suitable for different traditional light fixture with easy installation.
- Die casting aluminum heat dissipation and fan circulation air design, exchange cooling system to accelerate heat dissipation.
- High-luming LED 2835SMD, lamp light efficiency up to 130-140lm /W, Long life.
- No RF interference, No IR/UV radiation, No mercury pollution.
- Widely replace the CFL/MH/HID/HPS. Applied to the Canopy Lighting, High/Low bay Lighting, Road Lighting etc.

Applications

Gas station

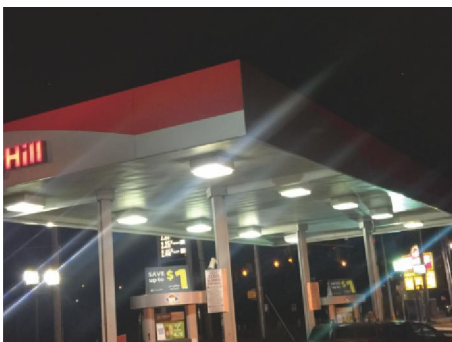

Parking lot

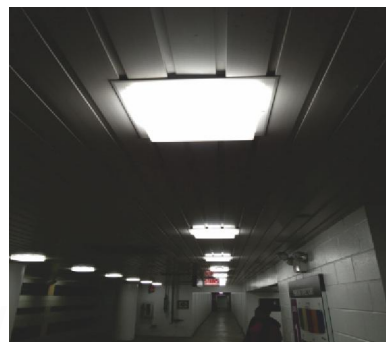

Corridor





Product datasheet

Technical data

Electrical data

Rated wattage	100-108W
Input Voltage	100-277V AC
Operating frequency	50/60 Hz
Rated power factory	>0.90
Power Efficiency	>0.87
Humidity	< 90%
Ambient temperature	-40 ~ 45°C
Base (standard designation)	E39/E40
Replacement conventional lamp power	330W HID
Dimmable	NO

Light technical data

Light Source/Count	351pcs 2835 0.5WSMD
Luminous flux	13500 Lm± 10%
Color temperature	WarmWhite: 3000 ~ 3,500K NaturalWhite: 4,000 ~ 5,000 K CoolWhite:5,500 ~ 6,500K
Color rendering index Ra	Ra >80
Starting time	0 S
LED Emitter Life	50000hrs
Lifepan of LED Lamp	35000hrs

Product datasheet

Dimensions & weight

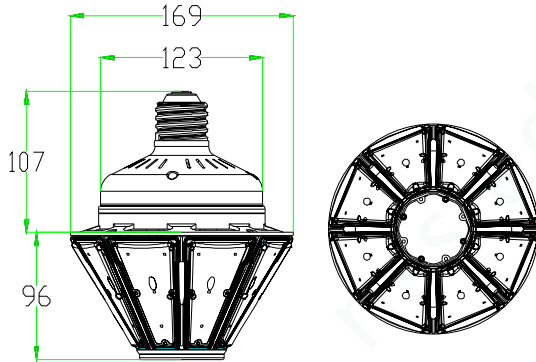

Base	E39/E40
Overall length	203mm
Diameter	169mm
N. W	1500g

Logistical Data

Package

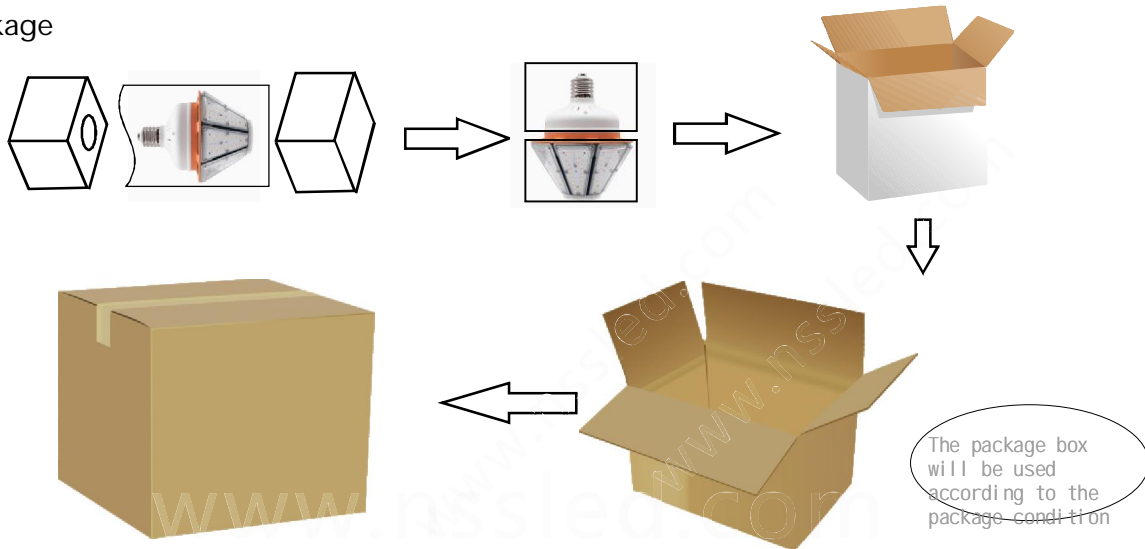

Packaging unit (Pieces/Unit)	Dimensions	Gross weight	Volume
Small box 1	20.5*20.5*24.5cm	1.6Kg	0.01m ³
Outer Carton 12	63*42.5*52cm	21Kg	0.14m ³

Product datasheet

Installation

Replace CFL

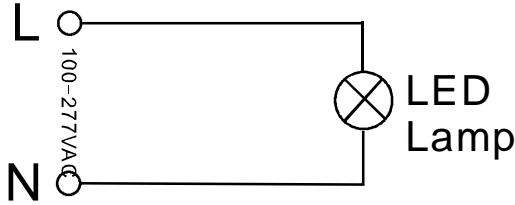
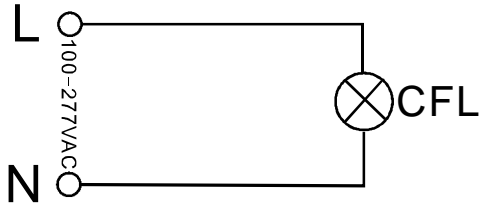

Replace HPS

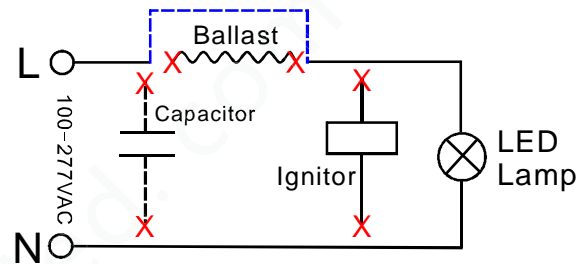
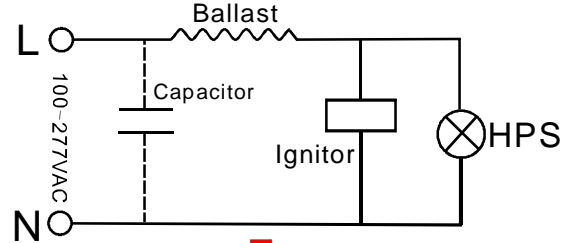

Light Distribution diagram

LUMINOUS INTENSITY DISTRIBUTION DIAGRAM

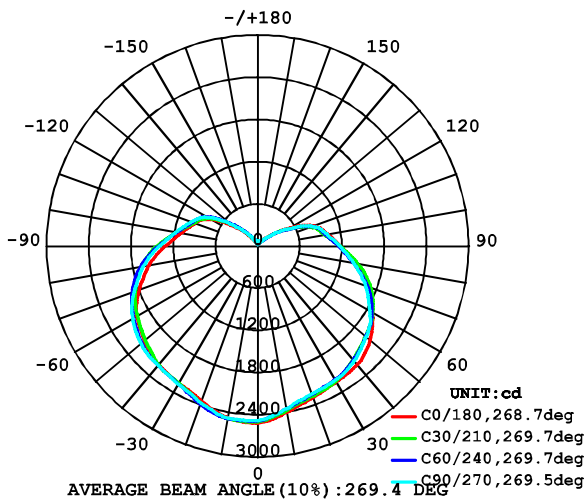

C0 PLANE ISOLUX DIAGRAM (UNIT:lx)

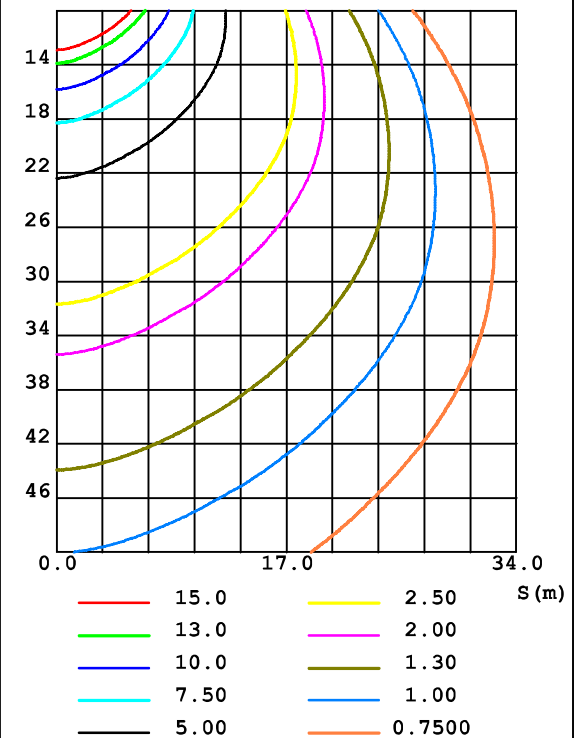

Product datasheet

Attention①

When the products are used in the outdoor lighting,ensure the space is waterproof and well ventilated.Pay attention to the size of the confined space.Ensure the lamp has enough space for heat dissipation which ensures lumen maintenance and extends its working life. As shown below, for your reference

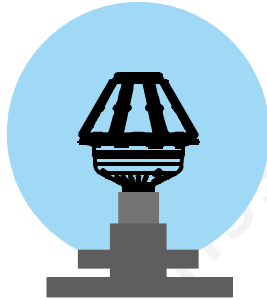

When 100W Garden light is used in confined space, the diameter must be more than 90cm.

Attention②

Key Benifits of comparison	LED Garden light 100W	HPS/HID/MH/CFL Lamp 330W
Luminous Flux(Lm)	13500	13200
Efficiency(Lm/W)	135	40
Better Color Appearance Measured in color Rendering index	83	98
Wide Color Availability In CCT(kelvin)	3000-6500	2500
Starting Time, Quick Start (min)	0	0
The life of the lamp(H)	35000	5000



LED Garden light 100W

Replacement

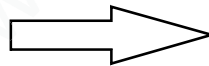

HPS/HID/MH/CFL Lamp 330W

Additional product data

All technical parameters apply to the entire lamp/Due to the complex production process for light-emitting diodes, the typical values shown for the technical LED parameters are purely statistical values that do not necessarily match the actual technical parameters of each individual product,which can vary from the typical value.

Disclaimer

Subject to change without notice. Errors and omission excepted. Always make sure to use the most recent release.