

NS-GLA30W-01C-U

LED Garden light



General illumination

Outdoor use in outdoor luminaires only (minimum Ip65)

Reduces lumen maintain flux and working life if used in sealed lamp fixtures. ①

## Features

- Specially designed for indoor and outdoor lighting. This lamp could replace the traditional lamp directly. suitable for different traditional light fixture with easy installation.
- Die-cast aluminum for heat dissipation, no fan design, Natural ventilation cooling system to accelerate heat dissipation
- High-luming LED 2835SMD, lamp light efficiency up to 140-150lm /W, Long life.
- Electric energy into light energy utilization rate of more than 80%, than traditional tube light save electricity above 70%;.
- Wide voltage input design, No RF interference, No IR/UV radiation, No mercury pollution.
- Widely replace the CFL/MH/HID/HPS. Applied to the Canopy Lighting, Garden Lighting, Road Lighting etc.

## Applications

### Garden Lighting

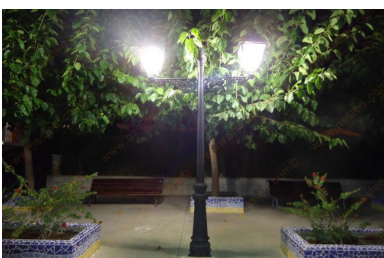

### Road Lighting

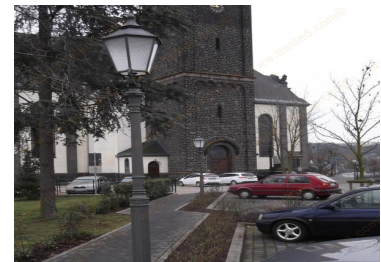
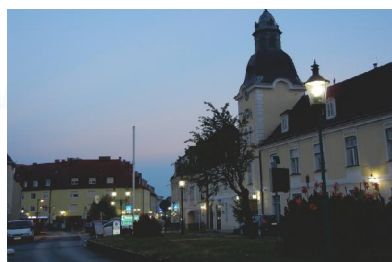

13321 Garden Grove Blvd, #N, Garden Grove, CA 92843



robert@nssled.com



+1.201. 969. 5019/ 323.616.7060( US)



www.nssled.com



## Product datasheet

### Technical data

#### Electrical data

Rated wattage	30-34W
Input Voltage	100-277V AC
Operating frequency	50/60 Hz
Rated power factory	>0.90
Power Efficiency	>0.87
Humidity	< 90%
Ambient temperature	-40~45°C
Base (standard designation)	E26/E27/E39/E40
Replacement conventional lamp power	100W HID
Dimmable	NO

#### Light technical data

Light Source/Count	120pcs 2835 0.5WSMD
Luminous flux	4350 Lm±10%
Color temperature	WarmWhite: 3000~3,500K NaturalWhite: 4,000~5,000K CoolWhite:5,500~6,500K
Color rendering index Ra	Ra >80
Starting time	0 S
LED Emitter Life	50000hrs
Lifepan of LED Lamp	35000hrs

## Product datasheet

### Dimensions & weight

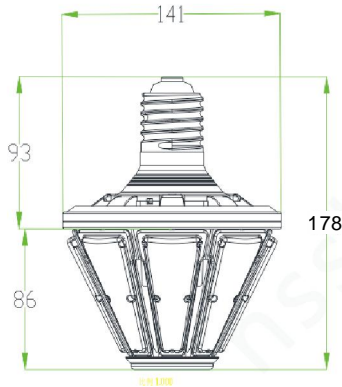

Base	E26/E27	E39/E40
Overall length	166mm	178mm
Diameter	141mm	
N. W	780g	800g

### Logistical Data

#### Package

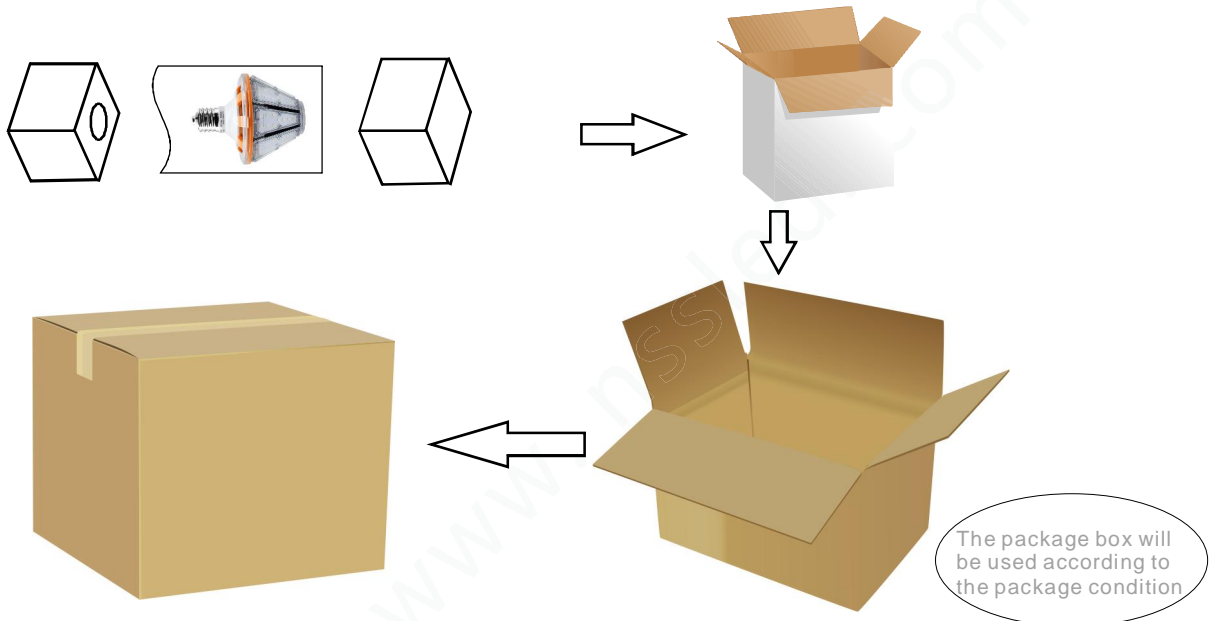

Packaging unit (Pieces/Unit)	Dimensions	Gross weight	Volume
Small box 1	17*17*22cm	0.9Kg	0.006m <sup>3</sup>
Outer Carton 18	52.5*52.5*47cm	18Kg	0.13m <sup>3</sup>

Product datasheet

Installation

**Replace CFL**

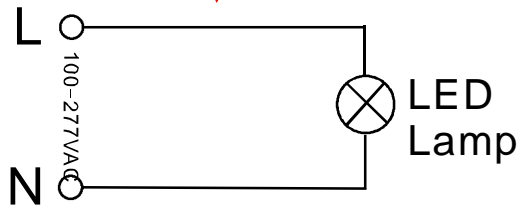
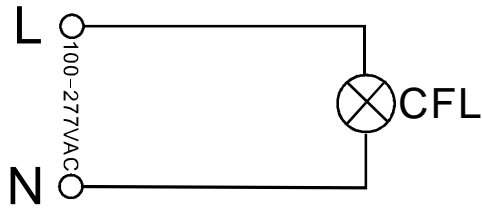

**Replace HPS**

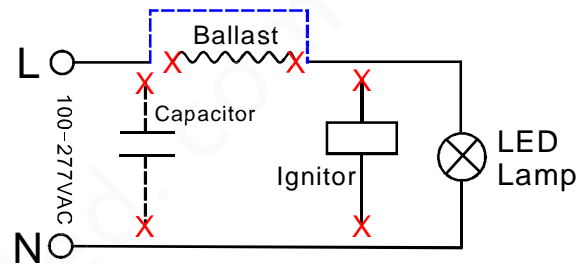
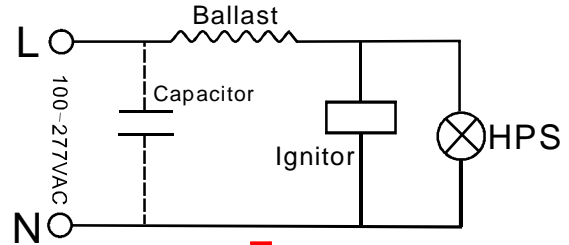

Light Distribution diagram

LUMINOUS INTENSITY DISTRIBUTION DIAGRAM

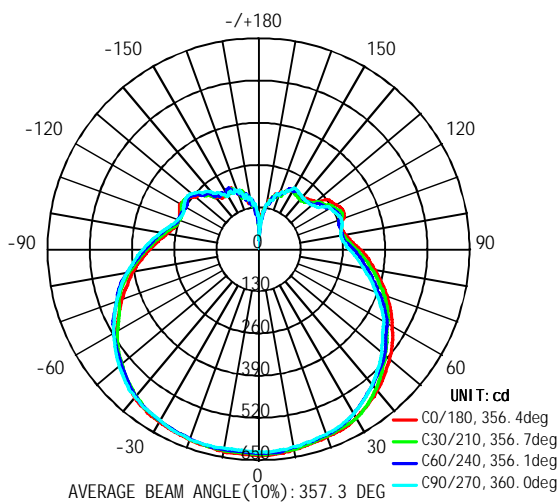

CO PLANE ISOLUX DIAGRAM (UNIT:lx)

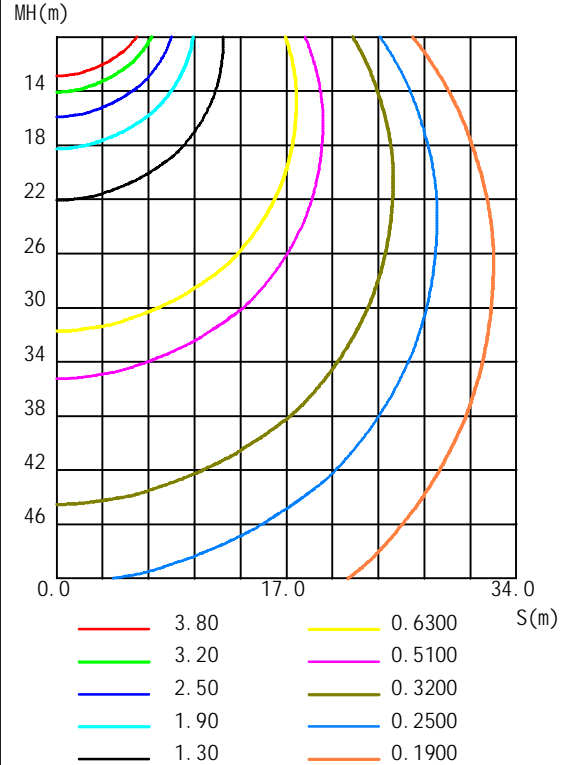

## Product datasheet

### Attention①

When the products are used in the outdoor lighting,ensure the space is waterproof and well ventilated.Pay attention to the size of the confined space.Ensure the lamp has enough space for heat dissipation which ensures lumen maintenance and extends its working life.

As shown below, for your reference

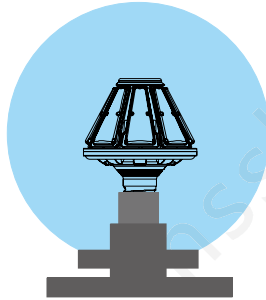

When 30W Garden light is used in confined space, the diameter must be more than 35cm.

### Attention②

Key Benifits of comparison	LED Garden light 30W	HPS/HID/MH/CFL Lamp 100W
Luminous Flux(Lm)	4200	4000
Efficiency(Lm/W)	140	40
Better Color Appearance Measured in color Rendering index	83	98
Wide Color Availability In CCT(kelvin)	3000-6500	2500
Starting Time, Quick Start (min)	0	0
The life of the lamp(H)	35000	5000



LED Garden light 30W

Replacement

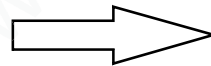

HPS/HID/MH/CFL Lamp 100W

### Additional product data

All technical parameters apply to the entire lamp/Due to the complex production process for light-emitting diodes, the typical values shown for the technical LED parameters are purely statistical values that do not necessarily match the actual technical parameters of each individual product,which can vary from the typical value.

### Disclaimer

Subject to change without notice. Errors and omission excepted. Always make sure to use the most recent release.