

Product datasheet

NS-TWL150W-01-C

LED Temporary work Light



Features

- 360 degree luminescence, no fan design. Adopt high heat conduction and portable stamping aluminum to accelerate heat dissipation.
- Wide pressure isolating constant current power supply, anti-surge protection of 6000V. The lamp can withstand sudden high voltage.
- Provide socket connector, which can connect 8 lamps in series at the same time.
- It can be used as HIGH BAY with spotlights and stainless steel protective cover.
- Suitable for outdoor wet or humid places. IP64 waterproof rating.
- Stainless steel hooks are more convenient to use.

Applications





Product datasheet

Technical data

Electrical data

Rated wattage	150-158w
Input Voltage	100-277V AC
Operating frequency	50/60 Hz
Rated power factory	>0.90
Power Efficiency	>0.87
Humidity	< 90%
Ambient temperature	-40 ~ 45°C
Replacement conventional lamp power	450W HID
Dimmable	NO

Light technical data

Light Source/Count	1064pcs 2835 0.2WSMD
Luminous flux	18750 Lm ± 10%
Color temperature	WarmWhite:3000 ~ 3,500K NaturalWhite:4,000 ~ 5,000 K CoolWhite:5,500 ~ 6,500K
Color rendering index Ra	Ra >80
Starting time	0 S
LED Emitter Life	50000hrs
Lifepan of LED Lamp	35000hrs

Product datasheet

Dimensions & weight

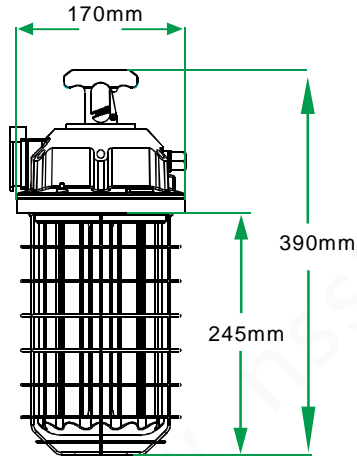

Overall length	390mm
Diameter	170mm
N. W	2.4kg

Logistical Data

Package

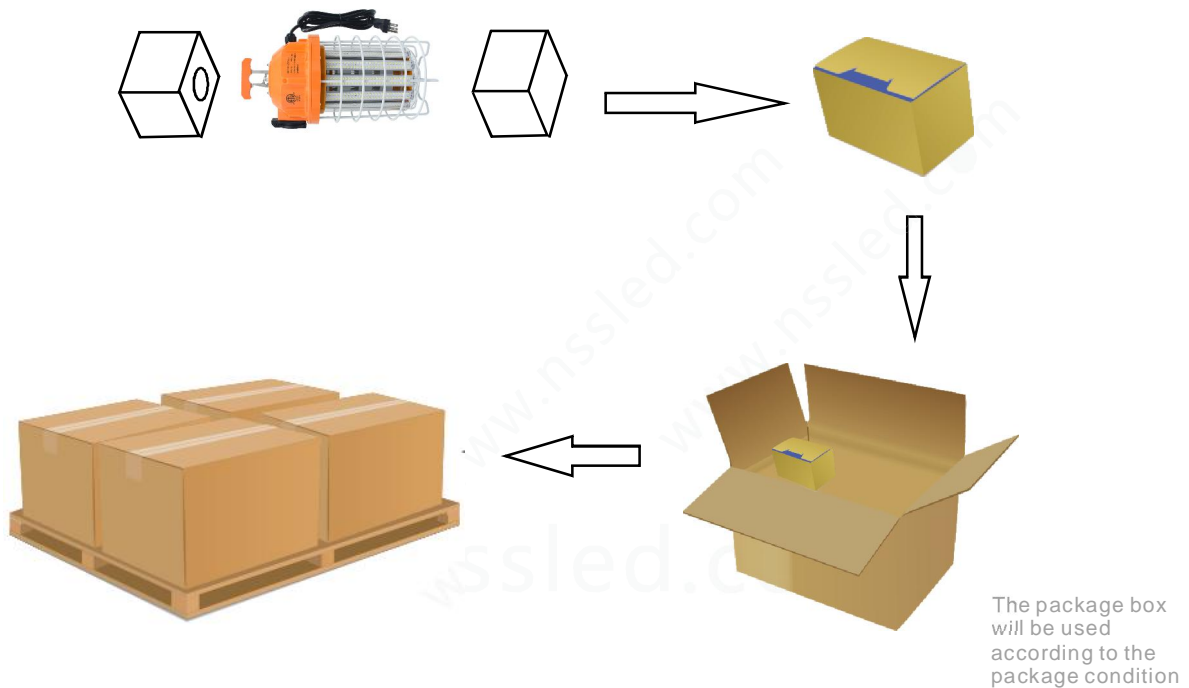

Packaging unit (Pieces/Unit)	Dimensions	Gross weight	Volume
Small box 1	42.5*21.5*22cm	2.6Kg	0.02m ³
Outer Carton 4	44*44.5*46cm	12.5Kg	0.09m ³

Installation

Replace CFL

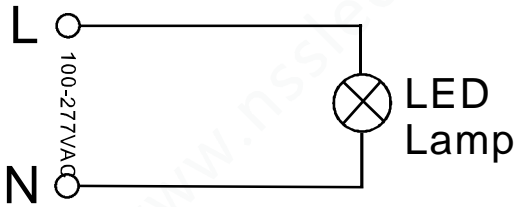
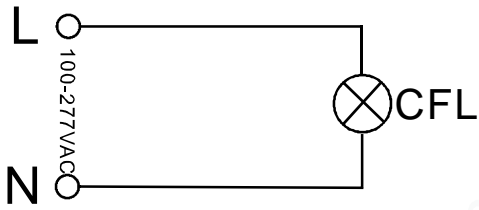

Replace HPS/HID/MH

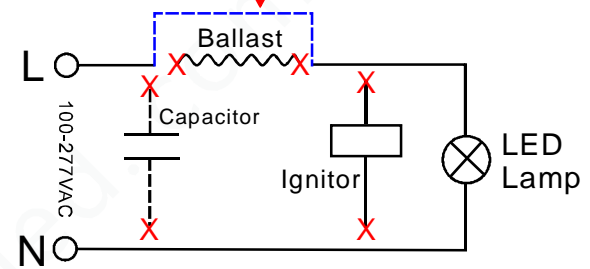
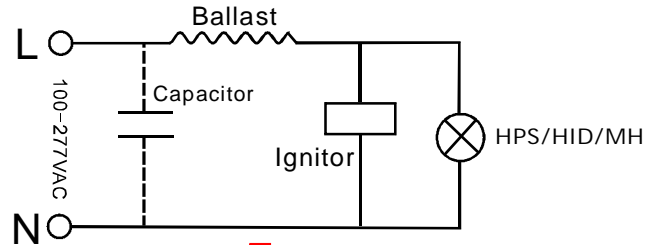

Light Distribution diagram

LUMINOUS INTENSITY DISTRIBUTION DIAGRAM

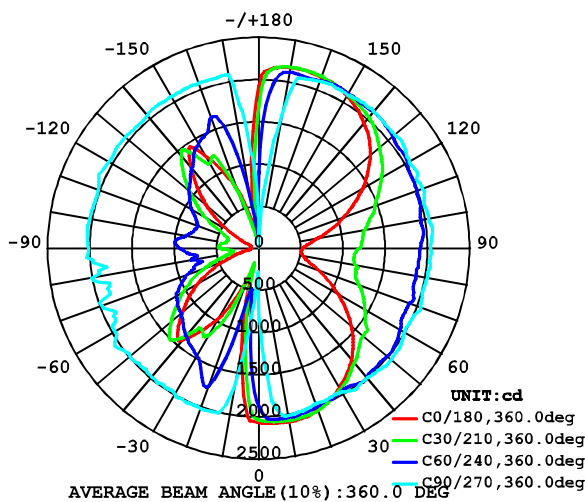

C0 PLANE ISOLUX DIAGRAM (UNIT:lx)

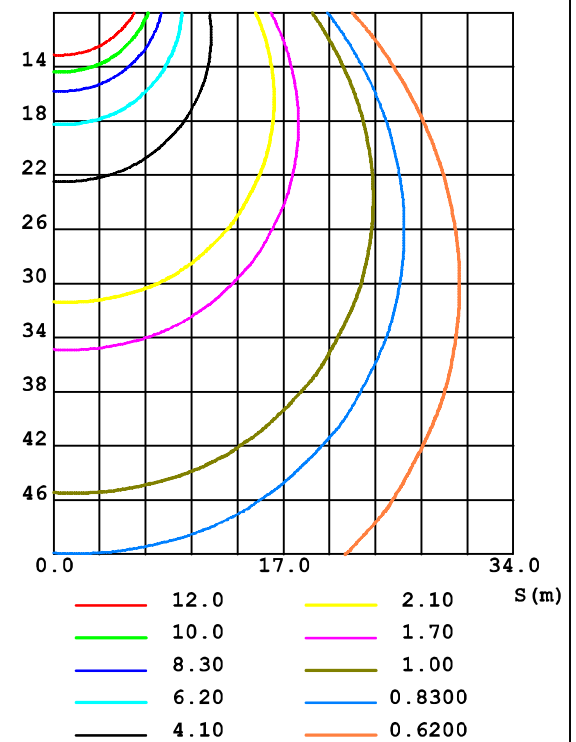

Product datasheet

Attention①

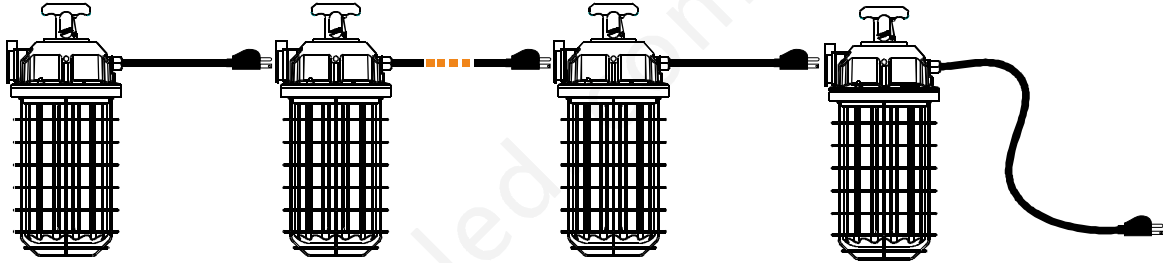

- * which can connect 8 lamps in series at the same time.
- * The standard length of 150W input plug wire is 5 meters

Attention②

Key Benifits of comparison	LED Temporary work light 150W	HPS/HID/MH Lamp 450W
Luminous Flux(Lm)	18750	18000
Efficiency(Lm/W)	125	40
Better Color Appearance Measured in color Rendering index	83	98
Wide Color Availability In CCT(kelvin)	3000-6500	2500
Starting Time, Quick Start (min)	0	0
The life of the lamp(H)	35000	5000



LED Temporary work light 150W

Replacement

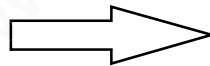

HPS/HID/MH Lamp 450W

Additional product data

All technical parameters apply to the entire lamp/Due to the complex production process for light-emitting diodes, the typical values shown for the technical LED parameters are purely statistical values that do not necessarily match the actual technical parameters of each individual product,which can vary from the typical value.

Disclaimer

Subject to change without notice. Errors and omission excepted. Always make sure to use the most recent release.